

ELECTRONIC CONTROL UNIT FOR TWO 12VDC MOTOR

UNIK2E _ V2

(COMPLETE)

UNIK2ESK _ V2

(WITHOUT BOX AND TRANSFORMER)

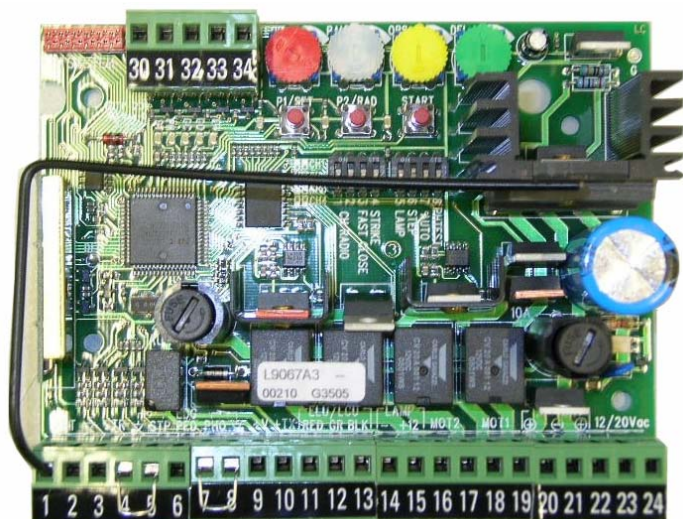

BOX IP 54

TECHNICAL INSTALLATION MANUAL FOR AUTOMATIC GATES



WARNING!

Before installing, thoroughly read this manual that is an integral part of this Kit. Prastel S.p.A. declines any responsibility in the event current standards in the country of installation are not complied with



The symbol CE conforms with European Directive R&TTE 99/05/CE

1. INTRODUCTION	3
2. MAIN FEATURES	3
3. TECHNICAL SPECIFICATIONS	3
4. CONNECTION AND SET UP OF THE CONTROL UNIT	4
4.1 GENERAL DIAGRAM OF SETTINGS AND CONNECTIONS	5
4.2 SIMPLIFIED LEARNING PROCEDURE (also see pages 8-10)	6
4.3 PROFESSIONAL LEARNING PROCEDURE (see also pages 8-10)	7
5. CONTROL UNIT OPERATING LOGIC (ANALYTIC EXAM)	8
5.1 PROGRAMMING AND CANCELLATION OF THE REMOTE CONTROLS	8
5.2 OPERATION OF THE SAFETY DEVICES	8
5.3 MOTOR SPEED - TRIMMER "FOR"	9
5.4 DELAY BETWEEN MOTORS - TRIMMER "DEL"	9
5.5 "OPENING AND CLOSING" OPERATING MODE	9
5.6 "PEDESTRIAN OPENING" FUNCTION	11
5.7 "OBSTACLE SENSITIVITY" DETECTION - TRIMMER "OBS"	11
5.8 FLASHING LIGHT	11
5.9 GATE OPEN WARNING LIGHT	11
5.10 SLOW-DOWN	11
5.11 ELECTRIC LOCK	11
5.12 COURTESY LIGHT	12
5.13 BUFFER BATTERY – SOLAR PANEL MANAGEMENT	12
5.14 LOGICAL STOP (STP INPUT)	12
5.15 CONTROL UNIT MEMORY FAULT	12
6. SIGNALLING LED	12
7. PROGRAMMING THROUGH GTSYSTEM	13
8. ACCESSORIES ABSORPTION CHECK INFORMATION	13
9. TROUBLESHOOTING	14
SAFETY WARNINGS FOR INSTALLATION AND USE	15

1. INTRODUCTION

The universal self-learning UNIK2E control unit has been designed for the automation of an access with 1 or 2 12VDC (24VDC)* motors with or without limit switches. **Its innovative self-learning procedure makes for quick and easy installation and its three trimmers permit fine adjustment of all main parameters: force (or speed), pause time, obstacle detection sensitivity and closing delay between the two leaves of the gate when two motors are used.**

The following are available:

- **simplified programming**, thanks to which the unit automatically performs a learning operation to acquire running time and determine slow-down setting at ninety percent of opening and closing runs;
- A **professional programming** in which the installer can determine the **instant in which the gate starts to slow-down**, the enabling of the **pedestrian opening via radio**, the **safety device trigger mode**.

2. MAIN FEATURES

- Management and control of 12 VDC (or 24 VDC)* powered, 1 or 2 motor-driven automated accesses
- Motors closing offset adjustable from 0 to 15 seconds using trimmers
- Double limit switch input open close
- Motor force (speed) adjustable from 50-100%.using a trimmer.
- Customisable partial opening (for pedestrian transit)
- Softstart (slow motor start)
- 1 to 60" stand-by time adjustment via trimmer.
- 0.1 to 3.0" obstacle detection triggering time adjustment via trimmer.
- Initial settings using dip-switches
- Signalling LEDs (8)
- Expansion for electric lock 12V 15W max (optional board ELU)
- Expansion for courtesy light 230VAC 500W max (optional board LCU)
- Built in battery charger with solar panel management
- Box predisposed for optional 12V 1.2Ah battery for emergency manoeuvres (max connectable battery 7Ah)
- Built-in 433MHz rolling-code receiver with 180 memorisable codes
- Flash microprocessor re-programmable on-board via serial interface.
- Programming and control of the control unit using a portable terminal GTSYSTEM (optional)
- Built to European reference Directive Standards (R&TTE 99/05/CE)

DECLARATION OF CONFORMITY

Prastel S.p.A. declares that **UNIK2E** IS IN ACCORDANCE with the 99/05/EC (R&TTE) directive

The complete declaration of conformity is available in Prastel or to the internet address www.prastel.it

3. TECHNICAL SPECIFICATIONS

Transformer power supply:	230VAC
Control unit power:	12VAC (20VAC)*
Motor output:	12 VDC max 2 x 50Watt (24VDC max 2 x 60W)*
Max current peak of motor:	10 Amperes
Accessories power:	12 VDC - 250 mA protected by fuse (see info page 13)
Environmental operating temperature :	-20°C / + 55°C
Programming parameters:	memorised in EEPROM
BOX IP rating:	IP54

(*)When using 24VDC motors, replace the supplied transformer with a 230/20VAC transformer with at least 20VA more power than the motor. The maximum power of the 24VDC motor driven by the control unit is 120W. Only 12V batteries can be connected to the control unit, so when there is no mains power 24VDC motors will be powered at 12VDC.

4. CONNECTION AND SET UP OF THE CONTROL UNIT

- a) Before installing the UNIK2E control unit, read the “General safety warnings and notes” (page 13).
- b) Fix the box using the special fixing holes.
- c) Mount a differential thermo-magnetic circuit breaker 6A (IC=30mA) on the mains supply as specified in the current reference standards (IC = differential current).
- d) Place the supplied cable-ways and insert the cables keeping the power and supply cables separate from each other.
- e) Connect the external accessories making sure that the total of the **average absorption of all the connected accessories** is less than the maximum current available (see info page 11).
- f) **ATTENTION: Connect the limit switches if present; otherwise do not jump inputs FC1, FC2, FO1 and FO2 in the terminal board.**
- g) **ATTENTION: if there are no electrical limit switches and no mechanical stop in opening, proceed as follows to define the manoeuvre times during learning:**
 - Press pushbutton 1 of the remote control or pushbutton P1/SET to stop the gate in the desired position.
 - Press pushbutton 2 of the remote control or pushbutton P2/SET to stop the gate in the desired position.
- h) Check the correct connection and operation of all the accessories connected to the terminal board.

NOTES:

INITIAL FACTORY SETTINGS

If there is no programming, the control unit will operate as follows:

- Step-step mode with automatic closing disabled.
- No slow-down
- Closing safety present
- No opening safety
- Obstacle detection trigger time (OBS) 1 second
- 3 second opening and closing time of the motors
- Safety test disabled
- Kick-back disabled
- Pushbutton 1 of transmitters enabled
- Rapid re-closing disabled

INITIAL SETTING OF THE TYPE OF OPERATOR

Check that the control unit is set for the application requested. When switched on, the red “RAD” LED flashes for the number of times set in the control unit.

NUMBER OF FLASHES	APPLICATIONS
1	Linear actuators
2	Operators with variable lever (Variable absorption)

To modify the setting proceed as follows:

1. press the P2/RAD pushbutton until the corresponding red “RAD” LED lights up
2. press the P1/SET pushbutton, the control unit switches to another application
3. press the P2/RAD pushbutton again to exit the programming
4. The red “RAD” LED switches off to confirm that programming has been exited.

MOTOR POWER SUPPLY

The control unit adapts itself to run with motors of 12 or 24VDC according to the voltage with which it is powered.

The UNIK2E control unit is fitted with a toroidal transformer with a 12VAC secondary.

4.1 GENERAL DIAGRAM OF SETTINGS AND CONNECTIONS

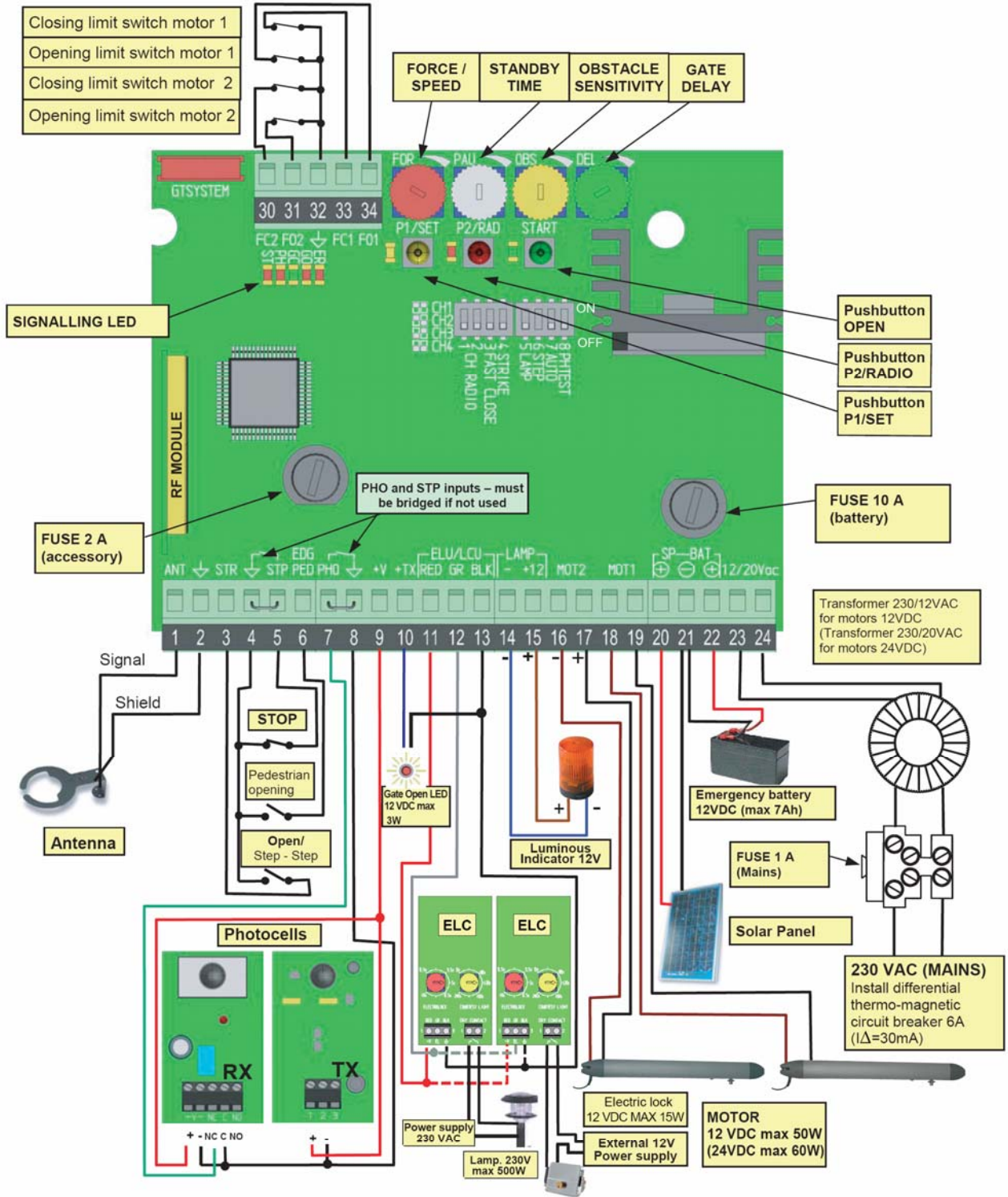

NOTE: The control unit is supplied with a trimmer to adjust the force of the motors set on maximum value (100%). Maintain this setting, which facilitates installation in difficult conditions (worn-out or not lubricated hinges, stress points etc.). Afterwards, reduce the force to obtain an operator movement that is slower and requires less force. **After having adjusted the force the learning procedure must be repeated.**

4.2 SIMPLIFIED LEARNING PROCEDURE (also see pages 8-10)

1. Verify the initial settings.
2. Program the remote controls (if needed) with the gate stopped (green LED GC turned on) according to the following:
 - a) Press the program button P2/RAD for two seconds: the red LED "RAD" lights up.
 - b) Press the desired button on each transmitter.
 - c) Press the program button P2/RAD to exit the programming mode.

LEARNING START:

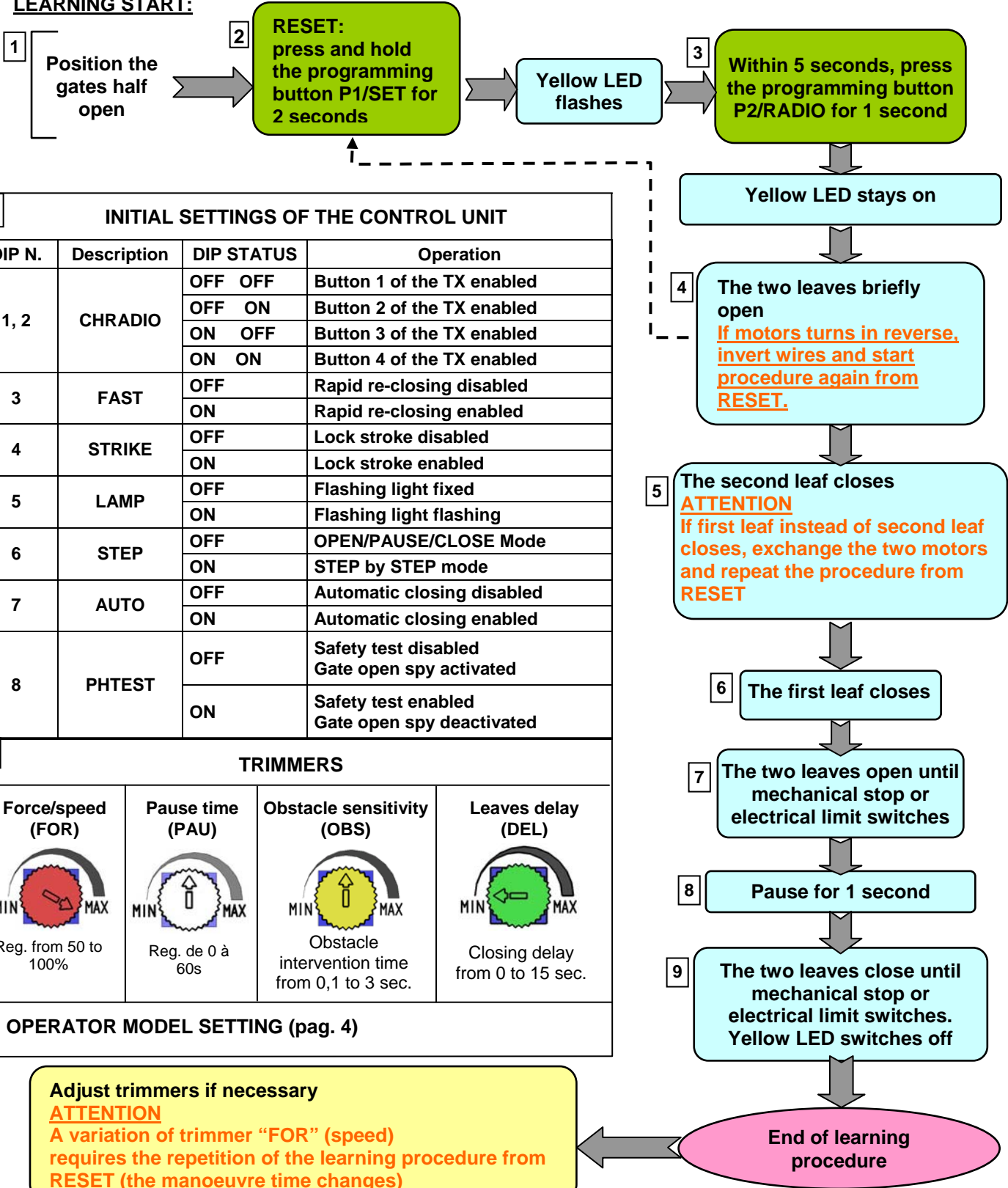

1 INITIAL SETTINGS OF THE CONTROL UNIT			
DIP N.	Description	DIP STATUS	Operation
1, 2	CHRADIO	OFF OFF	Button 1 of the TX enabled
		OFF ON	Button 2 of the TX enabled
		ON OFF	Button 3 of the TX enabled
		ON ON	Button 4 of the TX enabled
3	FAST	OFF	Rapid re-closing disabled
		ON	Rapid re-closing enabled
4	STRIKE	OFF	Lock stroke disabled
		ON	Lock stroke enabled
5	LAMP	OFF	Flashing light fixed
		ON	Flashing light flashing
6	STEP	OFF	OPEN/PAUSE/CLOSE Mode
		ON	STEP by STEP mode
7	AUTO	OFF	Automatic closing disabled
		ON	Automatic closing enabled
8	PHTEST	OFF	Safety test disabled Gate open spy activated
		ON	Safety test enabled Gate open spy deactivated

2 TRIMMERS			
Force/speed (FOR) Reg. from 50 to 100%	Pause time (PAU) Reg. de 0 à 60s	Obstacle sensitivity (OBS) Obstacle intervention time from 0,1 to 3 sec.	Leaves delay (DEL) Closing delay from 0 to 15 sec.

3 OPERATOR MODEL SETTING (pag. 4)

4.3 PROFESSIONAL LEARNING PROCEDURE (see also pages 8-10)

Using the professional learning procedure the installer can determine:

- a) the instant in which the opening and closing slow-down starts
- b) the pedestrian function
- c) the safety device trigger mode.

When the motor and the safety devices are connected, programme the remote controls to be used (see page 8) with the gate stopped (green LED GC turned on).

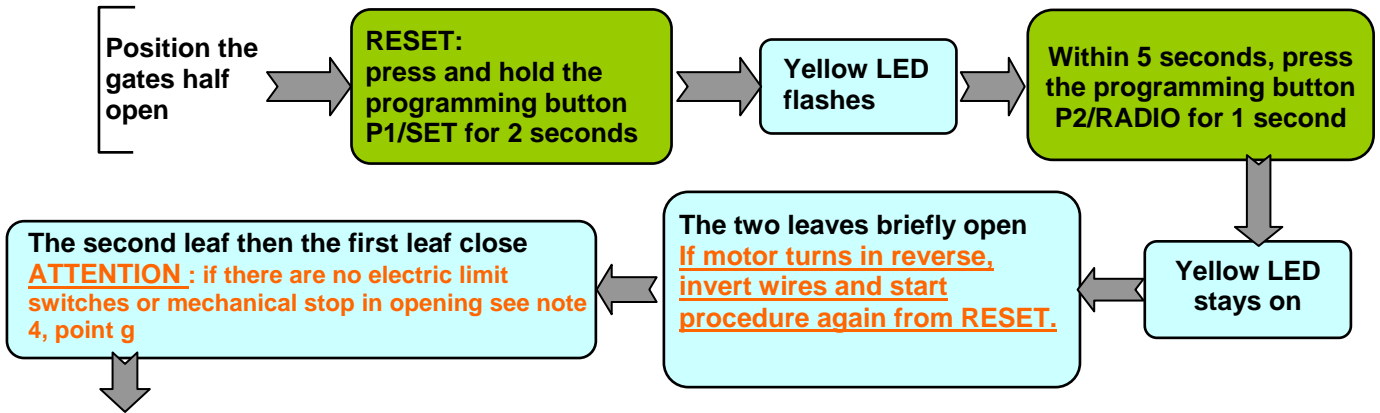

MANUAL INTERVENTION TO CHANGE THE FUNCTIONS

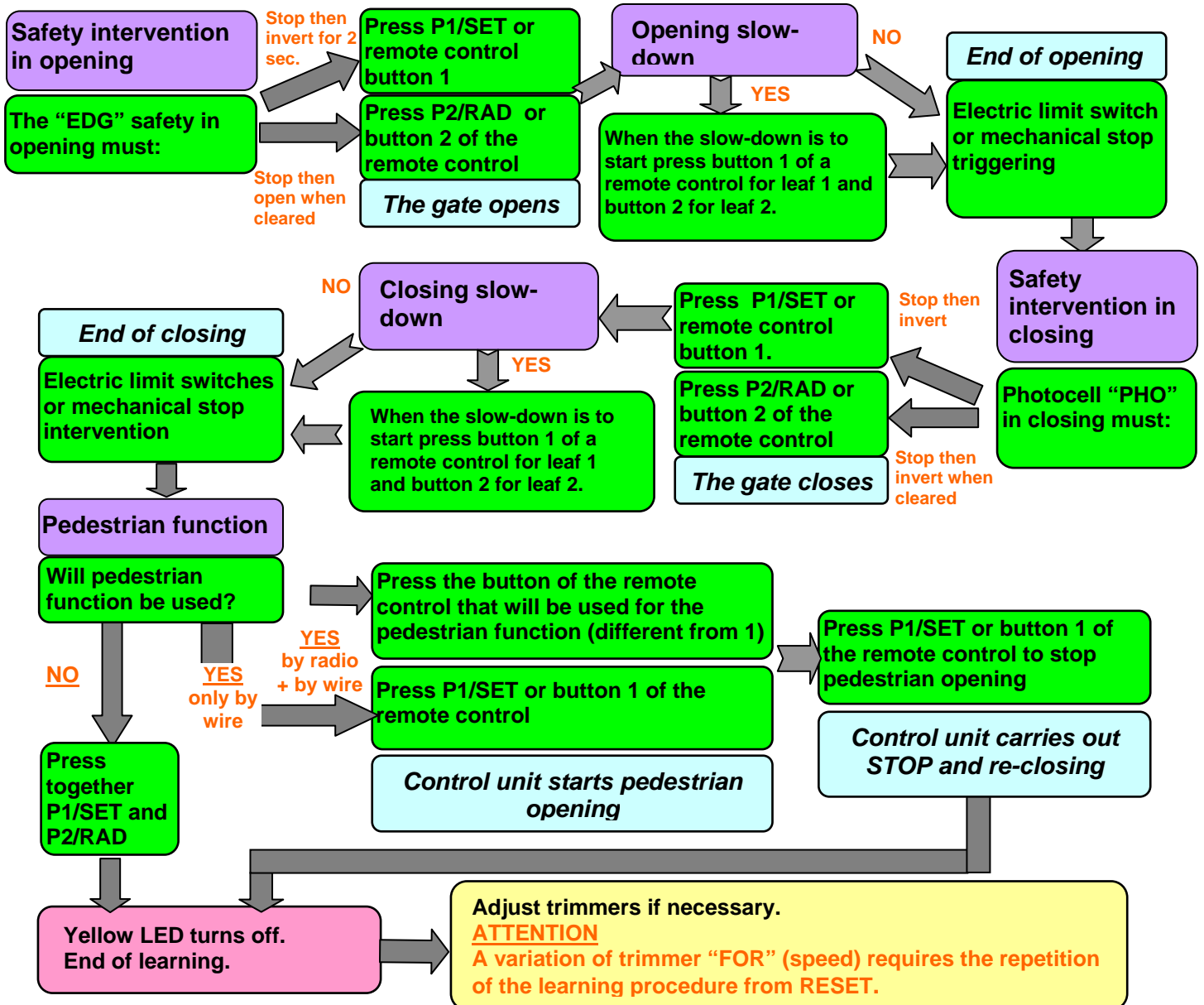

5. CONTROL UNIT OPERATING LOGIC (ANALYTIC EXAM)

5.1 PROGRAMMING AND CANCELLATION OF THE REMOTE CONTROLS

With the receiver built into the control box, Prastel dip-switch, fixed code and rolling code remote controls can be indifferently learned.

5.1.1 Programming

Power the control panel and with the **automation stopped (green LED GC turned on)**:

- Press the "P2/RAD" pushbutton: the red LED lights up to indicate that the programming is activated.
- Make a transmission by pressing one of the pushbuttons on the transmitter
- The code is memorised. During code insertion, the red LED flashes slowly. At the end, the red LED returns to a fixed light to indicate that a new remote control can be inserted.
- Memorise all the transmitters by carrying out a transmission with a chosen channel.
- At the end of the operation press the "P2/RAD" pushbutton again to exit the procedure. The red LED switches off.

ATTENTION: The exit from the procedure occurs automatically 10 seconds after the last transmission.

5.1.2 Total cancellation of the codes

- Press and hold down the "P2/RAD" pushbutton for 3 seconds; the red LED starts flashing quickly.
- Press the "P2/RAD" pushbutton again (within 6 seconds) to confirm the cancellation. The confirmation is signalled when the red LED starts flashing more rapidly.

5.1.3 Enabling new remote "Rolling Code" transmitters (RPA)

To enable a new transmitter without intervening on the receiver, a transmitter already enabled for the authorisation must be used (MPSTP2E, MPSTL2E, MPSTL4E, MT2E, MT4E, TRQ2 or TRQ4).

- With this authorised transmitter, press and release the RPA learning pushbutton (also see the instructions of the TX used).
- Carry out this operation 5-6 metres from the receiver (the LED signals the activation).
- Transmit by pressing one of the channel pushbuttons of the new transmitter to be enabled.
- Enable all the new transmitters by pressing a pushbutton on each one of them.
- The exit from the procedure occurs automatically 10 seconds after the last transmission.
- Check the effective programming of the transmitters by carrying out an opening manoeuvre with each of them.

5.1.4 Choosing the transmitter pushbutton

To select the radio channel that will activate the manoeuvre cycle set DIP 1 and 2 as follows:

DIP- SWITCH 1	DIP- SWITCH 2	Pushbutton Active
OFF	OFF	Pushbutton 1
OFF	ON	Pushbutton 2
ON	OFF	Pushbutton 3
ON	ON	Pushbutton 4

5.2 OPERATION OF THE SAFETY DEVICES

5.2.1 Photocell (PHO input)

When triggered, the photocell provokes:

- in closing phase, an inversion of the motion, either immediate or when cleared, according to the programming,
- in opening phase it has no effect,
- **when the access is closed it has no effect on the opening commands if set for immediate inversion, otherwise it delays the opening until it is cleared,**
- if the access is open it inhibits the closing commands.

The control unit has a function of rapid access closing after the triggering of the photocell (see paragraph 5.3.4).

5.2.2 Safety in Opening (EDG/PED input)

Safety devices can be connected (self-testing or not) to the "EDG/PED" input on the control unit (e.g. fixed wire ribs, pneumatically-operated ribs, etc.).

The safety acts as follows:

- in **closing phase it has no effect**
- in opening phase it provokes an inversion of direction for 2 seconds,
- when the gate is closed the opening commands are inhibited,

- when the gate is open the closing commands are inhibited,
- Using the professional learning, the EDG/PED input can be set as internal photocell:
- in closing phase it provokes an inversion of direction when cleared,
- in opening phase it provokes a STOP and opening continues when cleared,
- when the gate is closed it delays opening until it is cleared,
- when the access is open it inhibits the closing commands.

5.2.3 Safeties Self-test

The control unit has a self-test function of the safeties connected to the "PHO" input of the control unit; it switches off the transmitter to check the commutation of the corresponding receiver contact before the execution of each manoeuvre. In this case, the "gate open warning light" is not available.

To activate this self-test function proceed as follows:

- switch **DIP 8 "PHTEST" to ON**

- connect the positive of the photocell transmitter power to terminal 10 ("TX")

With the Self-test function active the **photocell transmitters are only powered when the manoeuvre is taking place**, thus giving a major saving of energy.

If the enabling of the safety self-test is not required

- switch **DIP 8 "PHTEST" to OFF**

- connect the positive of the photocell transmitter power to the terminal 9 ("V")

5.3 TRIMMER "FOR"- MOTOR SPEED

Trimmer "FOR" adjusts the voltage applied to the motors during operations, which means adjusting the speed of the motors. With the trimmer turned fully counter-clockwise the speed of the motor is 50% of the maximum speed.

With the trimmer at half travel the speed of the motor is 75% of the maximum speed.

ATTENZIONE: Changing the setting of trimmer "FOR" requires repeating the learning procedure, since the travel times and the slow-down start times change.

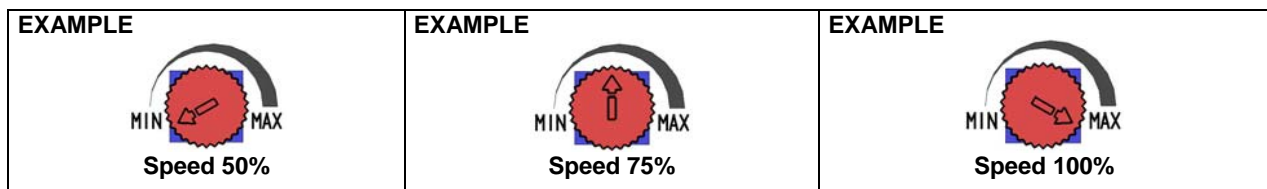

5.4 TRIMMER "DEL"- DELAY BETWEEN MOTORS

Trimmer "DEL" can be used to adjust the delay between the two motors in opening and closing operations.

If the trimmer is turned fully counter-clockwise, the delay is 0 both in opening and in closing, and the two leaves will move together. In all the other positions of the trimmer, the delay in opening is 3 seconds and the delay in closing varies from 0 to 15 seconds according to the position of the knob.

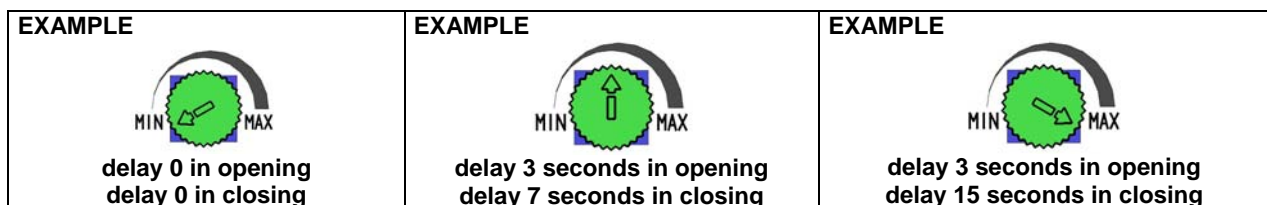

5.5 TRIMMER "PAU" - "OPENING AND CLOSING" OPERATING MODE

5.5.1 Time controlled automatic closing mode

Switch the **dip-switch 6** to OFF and the **dip-switch 7** to ON.

Set the "PAU" trimmer in an intermediate position according to the pause time desired. The pause time can be set between 3 and 60 seconds and is increased by rotating the trimmer clockwise.



In this mode, if a command is received via radio or via the "STR" input, the control unit does the following:

- drives the two motors without 2nd motor delay if the **DEL trimmer is turned fully counter-clockwise**, with a 2nd motor delay of 3 seconds for all the other positions of the DEL trimmer
- drives the motors for one second at reduced speed (softstart) and then at the speed set on the FOR trimmer.

- opening stops when the limit switches or the obstacle detection system intervenes or when the manoeuvre time has elapsed. If other commands are given during opening they will have no effect.
 - with the automation stopped and in automatic pause each time the timer re-starts from zero.
- Once the pause time has elapsed, the closing manoeuvre takes place and the control unit:

- carries out a 1 second fixed pre-flash
 - drives the two motors with a 2nd motor delay as set on the DEL trimmer
 - drives the motors for one second at reduced speed (softstart) and then at the speed set on the FOR trimmer.
 - if another command is given during closing the control unit commands a complete re-opening.
 - closing stops when the limit switch or the obstacle detection system intervenes or when the manoeuvre time has elapsed.
- ATTENTION: Maintaining the opening contact ("STR" terminal) closed, with a temporised relay for example, the control unit will command opening and the automation will remain open with automatic closing disabled until the contact is re-opened again (Company Function).**

5.5.2 Step by step mode without automatic closing

Switch the **dip-switch 6** to ON and the **dip-switch 7** to OFF.

The step by step command sequence is OPEN-STOP-CLOSE-STOP

The opening and closing manoeuvres take place as described in the previous paragraph.

5.5.3 Step by step mode with automatic closing

Switch the **dip-switch 6** to ON and the **dip-switch 7** to ON.

The step-step logic is OPEN/STOP/CLOSE/STOP.

When the opening manoeuvre has been completed and the pause time set on the PAU trimmer has elapsed the control unit effects automatic closing. If, when the automation is closed, a radio command is given, either through the "STR" input command or the START pushbutton on the board, the control unit:

- commands a one second fixed pre-flash
- drives the two motors without 2nd motor delay if the **DEL trimmer is turned fully counter-clockwise**, with a 2nd motor delay of 3 seconds for all the other positions of the DEL trimmer
- drives the motors for one second at reduced speed (softstart) and then at the speed set on the FOR trimmer.
- opening stops when the limit switch or the obstacle detection system intervene or when the manoeuvre time has elapsed or with a radio or manual command. In the latter case the control unit disables the automatic closing and another command must be given to re-start the manoeuvre. If the automation is completely open, once the pause time has elapsed the closing manoeuvre takes place. The control unit:
- commands a 1 second fixed pre-flash
- drives the two motors with a 2nd motor delay as set on the DEL trimmer
- drives the motors for one second at reduced speed (softstart) and then at the speed set on the FOR trimmer.
- closing stops when the limit switch or the obstacle detection system intervenes or when the manoeuvre time has elapsed.

5.5.4 Automatic closing and rapid re-closing mode

Switch the **dip-switch 6** to OFF and the **dip-switch 7** to ON.

Switch the **dip-switch 3** to ON.

The control unit does the following:

- a) if the photocell is triggered during opening, the control unit continues the opening, and when the photocell is cleared effects a STOP followed, after one second, by the re-closure.
- b) if the photocell is triggered during standby with the gate open, when the photocell is cleared, after one second, automatic re-closure occurs.
- c) if the photocell is triggered during closure, the control unit effects an inversion and, when the photocell is cleared, it effects a STOP followed, after one second, by the re-closure.

If during the opening cycle or during the pause the photocell is not triggered, the pause time is as set on the "PAU" trimmer.

5.5.5 OPEN-CLOSE-OPEN mode

Switch the **dip-switch 6** to OFF and the **dip-switch 7** to OFF.

If, when the automation is closed, a radio command is given, either through the "STR" input command or the START pushbutton on the board, the control unit:

- commands a one second fixed pre-flash
- drives the two motors without 2nd motor delay if the **DEL trimmer is turned fully counter-clockwise**, with a 2nd motor delay of 3 seconds for all the other positions of the DEL trimmer
- drives the motors for one second at reduced speed (softstart) and then at the speed set on the FOR trimmer.
- opening stops when the limit switch or the obstacle detection system intervenes or when the manoeuvre time has elapsed. If other commands are given during opening they will have no effect.

When the automation is completely open, to start closing give a radio or manual command and the control unit:

- commands a 1 second fixed pre-flash
- drives the two motors with a 2nd motor delay as set on the DEL trimmer

- drives the motors for one second at reduced speed (softstart) and then at the speed set on the FOR trimmer.
- if a command is given during closing the control unit commands the complete re-opening
- closing stops when the limit switch or the obstacle detection system intervenes or when the manoeuvre time has elapsed.

5.6 "PEDESTRIAN OPENING" FUNCTION

The pedestrian function can be assigned with the professional learning to channel 2/3/4 of the remote control. With a "PEDESTRIAN OPENING" ("EDG/EDG" terminal) command on the input, the control unit commands an **opening** for the first leaf for a time of:

- 5 seconds if no learning has been carried out,
- complete opening if a **simplified learning** has been carried out
- that set by the installer if a **professional learning** has been carried out.

Closing is triggered by a manual command, or automatically if the automatic closing function is enabled. The complete opening command has always priority over the pedestrian opening, therefore if, during a pedestrian manoeuvre a complete opening command is received, the control unit will command a complete opening of the automation.

5.7 TRIMMER "OBS" - "OBSTACLE SENSITIVITY" DETECTION

The "OBS" TRIMMER is used to adjust at the same time the delay time of intervention after an obstacle has been detected and the threshold of the counter-force against the operator necessary to trigger the intervention. **Both the counter-force and the delay time increase when the trimmer is turned clockwise.** The delay time can be adjusted between 0.1 and 3 seconds. This function is useful to overcome any critical points of the operator which cause a higher power absorption by the motor for a short time.

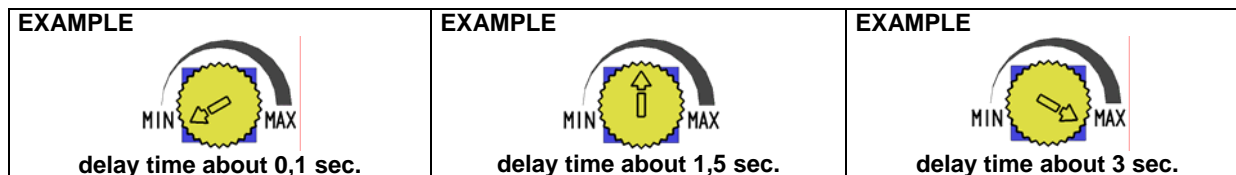

If **electric limit switches are present**, the obstacle detector will provoke an inversion of the motion in closing and a 2 second inversion in opening.

If there are no electric limit switches the obstacle detector provokes:

- in closing an inversion of the motion unless it is in the last five seconds of the manoeuvre, where does a STOP
- in opening an inversion of the motion for 2 seconds unless it is in the last five seconds of the manoeuvre, where does a STOP.

5.8 FLASHING LIGHT

The control unit has two output terminals (LAMP) to command a low voltage flashing light. The light start flashing 1 second before each opening manoeuvre and 1 second before each closing manoeuvre.

If the **dip-switch 5** is in the OFF position the power supply to the flashing light is continuous. Therefore the terminals must be connected to a low voltage flashing light with a built-in oscillating circuit (type FEBOLIX 12VDC 2W).

If the **dip-switch 5** is in the ON position the power supply is intermittent and therefore a normal lamp without oscillating circuit can be connected (12VDC, Max 10W). During the closing manoeuvre, the flashing frequency is twice as fast as that during opening.

The flashing light is only activated during movement. If AC mains power supply is missing and the unit works under battery power supply, the flashing light will only flash for the first 4 seconds of the manoeuvre.

5.9 GATE OPEN WARNING LIGHT

If the **safety device self-test is not used** (DIP 8 "PHTEST" is OFF), the output +TX (terminal 10) acts as a GATE OPEN WARNING LIGHT. Connect a 12V lamp (max. 3W) to terminals 10 ("TX") and 9 ("COMMON") of the control unit. The status of the lamp is as follows:

- If the access is closed the light is switched off
- If the access is open or opening the lamp is alight with a fixed light
- If the access is closing the lamp flashes

5.10 SLOW-DOWN

The slow-down function allows the gate to apply a reduced force before reaching the limit stop. The speed is reduced to about one third of the normal working speed.

The slow-down function can be enabled or not during the Professional Learning procedure. With this control unit the slow-down start can be selected independently for the two leaves, both in opening and closing.

5.11 ELECTRIC LOCK

Using the ELU expansion card an electric lock can be managed. The contact given by the ELU card is clean and allows the managing of electric locks of 12 or 24 Volt max.15W according to the output voltage of the

transformer. The command is given before every opening manoeuvre for 2 seconds, and before every re-opening caused by the triggering of a photocell or safety device.

Using **dip-switch 4** on the card, the kick-back and the final stroke at the end of the closing manoeuvre can be enabled or not.

Dip-switch 4 in ON position: kick-back and final stroke enabled

Dip-switch 4 in OFF position: kick-back and final stroke disabled.

5.12 COURTESY LIGHT

Using the LCU expansion card a courtesy light can be managed. The contact given by the LCU card is clean and allows a 230VAC max.500W lamp to be managed. The command to switch on the courtesy light is given before every manoeuvre and the contact remains activated for about 120 seconds from opening.

5.13 BUFFER BATTERY – SOLAR PANEL MANAGEMENT

The UNIK control unit is fitted with an automatic 13.7VDC battery charger, for which a 12V battery must be used, even for 24VDC motors. In this case, when there is no mains power the gate will travel at half normal speed and the accessories will be powered at 12VDC. The 12V 1.2Ah buffer battery (pre-arranged in the UNIK box) **allows a maximum of 5 reduced-speed manoeuvres** should the mains power supply be cutoff (as long as the interruption occurred less than 24 hours earlier). The control unit can manage batteries up to 7Ah (20-30 complete manoeuvres). The flashing light, when present, only functions for the first 4 seconds of the manoeuvre. A solar panel can be directly connected to the control unit with a current regulator. The solar panel input is already protected by a diode.

5.14 LOGICAL STOP (STP INPUT)

The activation of the STOP input stops all the functions.

To resume the cycle the STOP must be deactivated and another command given.

5.15 CONTROL UNIT MEMORY FAULT

The EEPROM memory contains the control unit operating parameters, the codes, the logic and the memory of the radio receiver. When the control unit is turned on, should there be a **fault in the EEPROM memory, the red LED flashes and all manoeuvres are blocked.**

The Reset function must be executed (press and hold the programming button P1/SET for 2 seconds, until the yellow LED flashes).

If the red LED turns off, the EEPROM is good, but all programming of parameters and learning of transmitters must be done again.

If the red LED still flashes, an authorised service centre should be contacted.

6. SIGNALLING LED

Yellow led SET:

- flashes for 5 seconds when turned on to indicate that it is possible to enter the Professional or Simplified Learning modes.
- lights up with a fixed light while Professional or Simplified Learning are carried out.
- is turned off when the control unit functions normally.

Red led ER:

- is turned off during normal control unit operations
- is alight (fixed light) when the control unit is blocked because it has failed the safety test or a motor is disconnected

Red led RAD:

- flashes briefly when a 433 MHz Multipass radio code is received
- is alight (fixed light) when radio codes are being memorised
- flashes rapidly when the control unit is switched on and the radio code memory is defective
- flashes rapidly during the cancellation of radio codes
- flashes slowly when there is an attempt to memorise new radio codes and the memory is full
- is switched off when the control unit is functioning normally and waiting to receive a command via radio.

Green led GC:

- is alight (fixed light) when the automation is **completely closed**
- flashes during the closing manoeuvre
- otherwise it is switched off

Red led GO:

- is alight (fixed light) when the **automation is open.**
- flashes during the opening manoeuvre
- otherwise it is switched off

Red led PH:

- is alight when the photocell (PHO input) **is aligned**
- is switched off when the photocell (PHO input) **is not aligned**

Red led ST:

- is alight when the STOP (STP) input **is closed**
- is switched off when the STOP (STP) input **is open**.

Green led START:

- is alight when the OPEN/STEP/STEP (STR) input **is closed**.
- is switched off when the OPEN/STEP/STEP (STR) input **is open**.

7. PROGRAMMING THROUGH GTSYSTEM

The GTSYSTEM is an autonomous multi-functional terminal that can be used on various Prastel products both for testing and function modification. In the case of UNIK2E control unit, it allows:

- modification or visualisation of operating parameters,
- visualisation of the counter of completed manoeuvres,
- visualisation of the control unit status and diagnostic messages.

**8. ACCESSORIES ABSORPTION CHECK INFORMATION
(Transformer dimensioning)**

The current available for the accessories is given by the power available for the accessories divided by the voltage of the accessories (13.7V).

$$I_{acc} = \frac{P_{acc}}{13.7}$$

I_{acc} = current available for accessories
 P_{acc} = power available for accessories

The power available for the accessories is given by the transformer power, less the motor power, less the power absorbed by the control unit (4W).

$$P_{acc} = P_{tras} - P_{mot} - 4$$

P_{tras} = transformer power
 P_{mot} = motor power 1 + motor power 2

Below are two examples of calculation of the current available for the accessories.

Control Unit	Transformer Power	Power absorbed by the motor	Power absorbed by the control unit	Power available for the accessories	Voltage of the accessories	Current available for the accessories
UNIK2E	80VA	70W	4W	6W	13.7V	430mA
UNIK2E	100VA	85W	4W	11W	13.7V	800mA

The following table shows the average absorption of the most common Prastel/VDS accessories:

Product	Absorption
Flashing Light FEBOLIX	150 mA
Photocell FOTO30SDE (couple TX+RX)	50 mA
Photocell FOTO35SDE (couple TX+RX)	50 mA
Induction detector MLX24AZ	40 mA
Receiver MR1E	20 mA
Microwave detector DM30	80 mA
Microwave detector DM60	100 mA
Amplifier for infra-red barrier FOTOTEST2D	30 mA
Pneumatic edge receiver TCO4RX	30 mA
Standalone keypad EASYBKA	100 mA
Standalone proximity reader EASYMINI	30 mA

Example: connecting 2 pairs of FOTO30SDE photocells, a FEBOLIX flashing light and a MLX24AZ detector the overall average absorption is 290mA. Should it be necessary to connect accessories with an overall average absorption that is more than that available, **the transformer must be replaced with a more powerful one**. For 12VDC motors use transformers with a secondary of 12VAC (for 24VDC motors use a transformer with a secondary of 20VAC).

9. TROUBLESHOOTING

PROBLEM	PROBABLE CAUSE	REMEDY
On giving a command with the remote control or with the key-switch, the gate does not open.	230 volt mains voltage absent	Check master switch
	Emergency STOP present	Check for any STOP commands connected to the STP input.
	There is no jumper between the STP input and the common.	If not used, check if there is a jumper on the STP input.
	One of the fuses is burnt out.	Replace the fuse with one of the same value.
	Motor power cable not connected or faulty.	Check the connection of the cable in the terminal board or replace it.
The gate opens but does not close.	The photocell, if present, is obstructed or not functioning.	Check, clean the photocell or remove the obstacle.
	The photocell is missing and there is no jumper between the PHO input and the common.	Check the accessory connections and the presence of the "jumper".
	A key selector NC contact has been used instead of an NO contact to connect to the STR input	Check the connections.
The operator functions by wire but not with the remote control.	The remote control has not been memorised or is broken or the battery is flat.	Check/change the battery. Carry out the remote control acknowledgement procedure.
The flashing light only functions for 4 seconds and the gate moves slowly (only with a 12V optional battery fitted).	No mains voltage: the control unit functions with the battery.	Check the lack of mains voltage.
		Functioning is normal because it is only powered by the battery.
The gate moves then stops, both in opening and closing.	The motor force is insufficient and/or the trigger threshold of the OBS is too low.	Check if the leaves are in axis, lubricate if necessary.
		Increase the trigger threshold by turning the OBS trimmer clockwise.
		If it is not sufficient, increase the FOR trimmer clockwise and reprogram from RESET
When commanded, the motor starts but the gate does not move.	There is an obstacle in front of the gate; the hinges are blocked; a motor fixing bracket has detached.	Remove any obstacles from the gate; restore the hinges, replace or lubricate them.
		Check the motor fixings.
	The electric lock, if present, does not work (does not open).	Check the electrical connection.
		Check the correct positioning.
		Lubricate the mechanism.

N.B.: If the problem persists, contact your Retailer or the nearest Service Centre.

ATTENTION: Before sending a remote control to be repaired, check that the batteries are not flat. 50% of all remote controls that return for servicing only have flat batteries.

SAFETY WARNINGS FOR INSTALLATION AND USE

These warnings are an essential, integral part of the product and must be given to the user. They provide important indications on the installation, use and maintenance and must be read carefully. This form must be preserved and passed on to subsequent users of the system. The incorrect installation or improper use of the product may be dangerous.

INSTALLATION INSTRUCTIONS

- The installation must be performed by professionally skilled personnel and in compliance with current local, state, national and European legislation.
- Before beginning the installation, check the integrity of the product.
- The laying of cables, electrical connections and adjustments must be workmanlike performed.
- The packing materials (cardboard, plastic, polystyrene, etc.) are a potential hazard and should be disposed of correctly and not left within reach of children.
- Do not install the product in potentially explosive environments or environments disturbed by electromagnetic fields. The presence of inflammable gases or fumes is a grave danger to safety.
- Set up a safety device for overvoltage, a disconnecting and/or differential switch suitable for the product and conforming to current standards.
- The manufacturer declines any and all responsibility for product integrity, safety and operation in the event incompatible devices and/or components are installed.
- Solely original spare parts should be used for repairs and replacements.
- The installer must provide all the information relative to the operating, maintenance and use of the individual components and the complete system as specified in the MACHINE LEGISLATION (see regulations EN 12635, EN 12453 and EN 12445).

MAINTENANCE

- To ensure product efficiency, it is essential that professionally skilled personnel carry out maintenance within the times established by the installer, the manufacturer and by current legislation.
- All installation, maintenance, repairs and cleaning operations must be documented. This documentation must be preserved by the user, and made available to the personnel responsible for the control.

WARNINGS FOR THE USER

- Read the instructions and enclosed documentation carefully.
- The product must be used for the express purpose for which it was designed. Any other use is considered improper and therefore hazardous. In addition, the information given in this document and in the enclosed documentation may be subject to modifications without prior notice. It is given as an indication only for product application. Prastel S.p.A. declines any responsibility for the above.
- Keep products, devices, documentation and anything else provided out of reach of children.
- In the event of maintenance, cleaning, breakdown or faulty operation of the product cut off the power and do not attempt to operate on the product except when indicated. Contact professional personnel, competent and suitable for the task. Failure to adhere to the above indications may be dangerous.

WARRANTY LIMITS

The warrantee is valid for 24 months from the date indicated in the sales document and its validity is limited to the original purchaser. It does not cover the following eventualities: negligence, incorrect or improper use of the product, use of accessories not conforming to the manufacturer's specifications, tampering by the customer or third parties, natural causes (lightning, floods, fire, etc.), riots, vandalism, modifications to the environmental conditions of the installation site. Nor does the warranty cover parts subject to wear (batteries, oil etc.). Products returned to PRATEL S.p.A. for repair shall only be accepted carriage paid. Prastel S.p.A. shall return the repaired product to the sender carriage forward. Otherwise the goods will be refused on receipt. The purchase of the product implies the full acceptance of all the general terms of sale. Any dispute shall be submitted for judgement to the Court of Bologna.